

## Directional spool valve type SW, SWP and NSWP

Directional spool valves are a type of directional valve. They control the direction of movement and the velocity of single and double-acting hydraulic consumers.

The directional spool valve type NSWP and SWP is available as a manifold mounting valve. Type NSWP is available with a nominal size 6 hole pattern (NG 6). Type SW is available as a single valve for pipe connection. The directional spool valve type NSWP can be flexibly adapted to different control tasks by means of additional functions in the pump line and/or on the consumer side (e.g. restrictors, restrictor check valves).

Intended applications for the directional spool valve type NSWP, SWP and SW include industrial hydraulics, in particular machine tools.

### Features and benefits:

- Compact valve banks possible
- Proportional functions easy to control
- Large range of variants
- Can be combined with NG6 sub-plates (type BA2)

### Intended applications:

- Machine tools
- Construction and construction materials machinery
- Offshore and marine technology
- Road vehicles



<b>Nomenclature:</b>	Directional spool valve
<b>Design:</b>	Individual valve for pipe connection Individual manifold mounting valve Valve bank manifold mounting Combination with hydraulic power packs
<b>Actuation:</b>	Solenoid
<b>p<sub>max</sub>:</b>	315 bar
<b>Q<sub>max</sub>:</b>	25 l/min

### Design and order coding example

NSWP2 G /M /R / ABR1,0 /50 /G24 - 3/8

**Single connection block** for direct installation in the pipe G 3/8 (type NSWP and SWP2)

**Voltage of the actuation solenoids** 12V DC, 24V DC, 110V AC, 230V AC

- Solenoids with various plug versions

**Pressure switch or pressure gauge at A or B**

**Additional elements at A and/or B** Restrictor check valve or orifice

**Additional elements at P** Check valve or orifice

**Solenoid version**

- black/white solenoid or proportional solenoid
- Solenoid with detent
- Solenoid version conforming ATEX (p<sub>max</sub> = 210 bar)

**Function**

- Indiv. valve with check valve or orifice in gallery P and/or check valve in gallery R (type SWP)
- Indiv. valve with 6/2-way function

**Basic type, size** Directional spool valve SW, SWP size 1 and 2  
NSWP size 2, connection hole pattern NG 6 (CETOP)

## Function

### Individual connection blocks:

- 1/4 S(R)

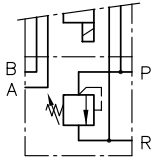

Sub-plate with pressure limiting valve<sup>1)</sup>

- 3/8

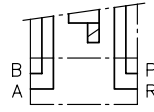

Sub-plate<sup>2)</sup>

1) Only for type SWP 1

2) Only for type NSWP and SWP 2

### Valve sections:

#### Basic symbol

#### Individual valve

SW

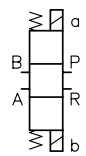

SWP / NSWP

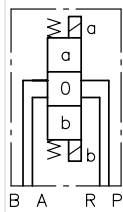

### Valve sections:

#### Circuit symbol

May be connected either in parallel or in series within a valve bank

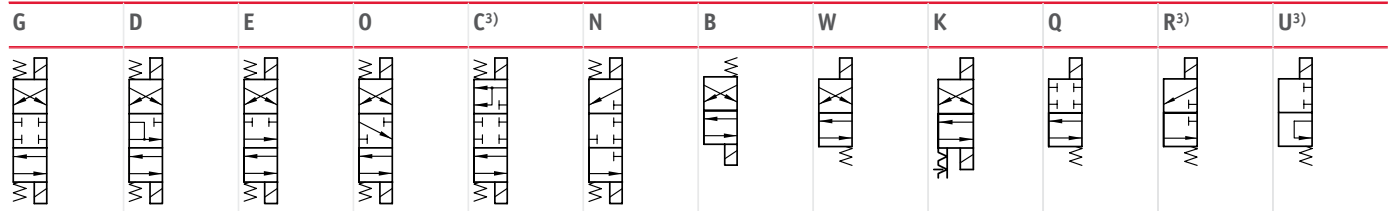

Only connected in series within a valve bank (only type SW1)

Spool for proportional adjustment

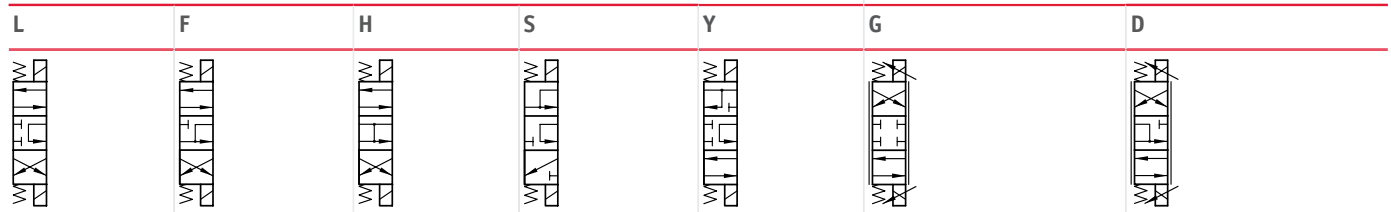

3) Only for type SWR 1

General parameters and dimensions

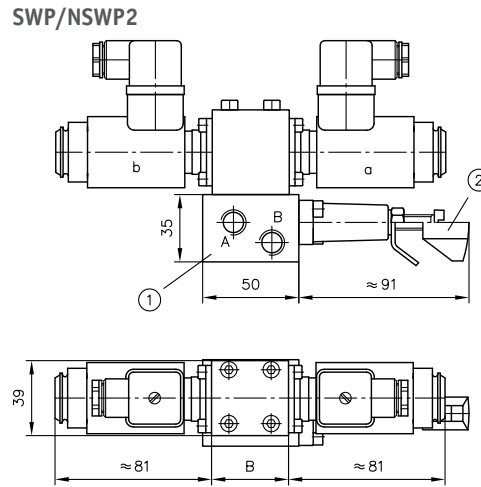
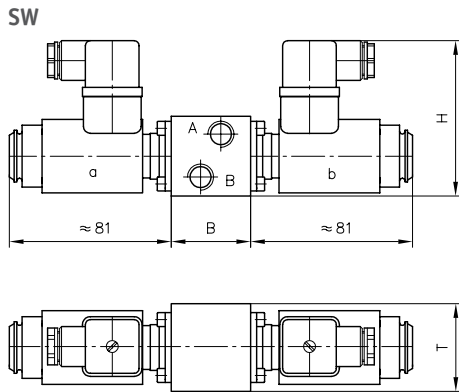

- 1 Single connection block
- 2 Pressure-limiting valve

	Q <sub>max</sub> [lpm]	p <sub>max</sub> [bar]	Ports	Dimensions [mm]			m [kg]	
				H	B	T	Individual directional spool valve	Sub-plate
SW/SWP 1	12	315	G 1/4	77 ... 90	40	40 ... 44	1.1 ... 1.5	0.6 ... 0.7
SW/SWP 2	25	315	G 3/8, G 1/4	78 ... 82.5	60 ... 70	40 ... 45	1.1 ... 2.4	0.8
NSWP2			NG 6					

Circuit example 1:

- BA2-A5 -NSWP2G/M/03/NZP16V/PQ20/0
- NSWP2G/M/R/B1,0
- NSWP2K/M/20/0
- NSWP2K/M/20/NZP16Q33/0
- 2-L24

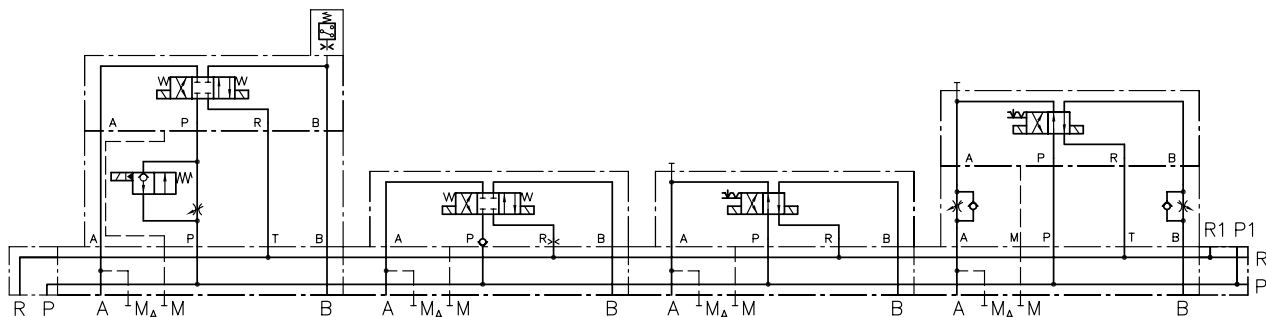

## Circuit example 2:

HKF44V9LD/1-Z16

- AL21D10V-F60/80-2
- BA2-NSMD2K/G/B2/O
- NSMD2G/GRK/B2/O
- NSWP2W/M/B1.0/06/S/O
- NG6X/O
- NSWP2W/M/B1.0/06/S/O
- NSMD2G/GRK/B2/O
- NG6X/O
- NSMD2K/G/B2/O
- 80-AC2001/40-X24

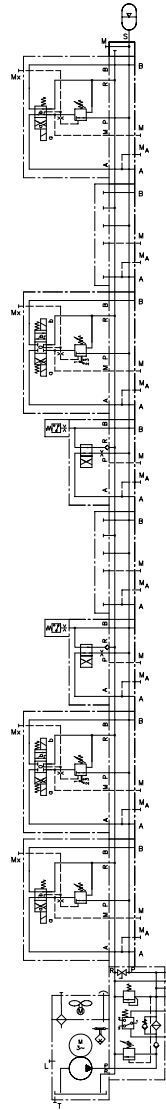

### Combinable products:

- Valve bank type BA: [D 7788](#)
- Intermediate plate type NZP: [D 7788 Z](#)
- 6/2-directional spool valve: **Sk 7951-J-6/2**

### Similar products:

- Valve banks type SWR, SWS: [D 7451](#)
- Clamping modules type NSMD: [D 7787](#)

### Associated technical data sheets:

- [Directional spool valve type SW: D 7451](#)
- [Directional spool valve type NSWP 2: D 7451 N](#)

### Male connectors:

- [Line connector type MSD and others: D 7163](#)
- With economy circuit: [D 7813](#), [D 7833](#)